

Article number: 12308100100110
Description: KLEE-coil 308 100 100.110
M10 Hardened/zinc-plated Blue

Measures

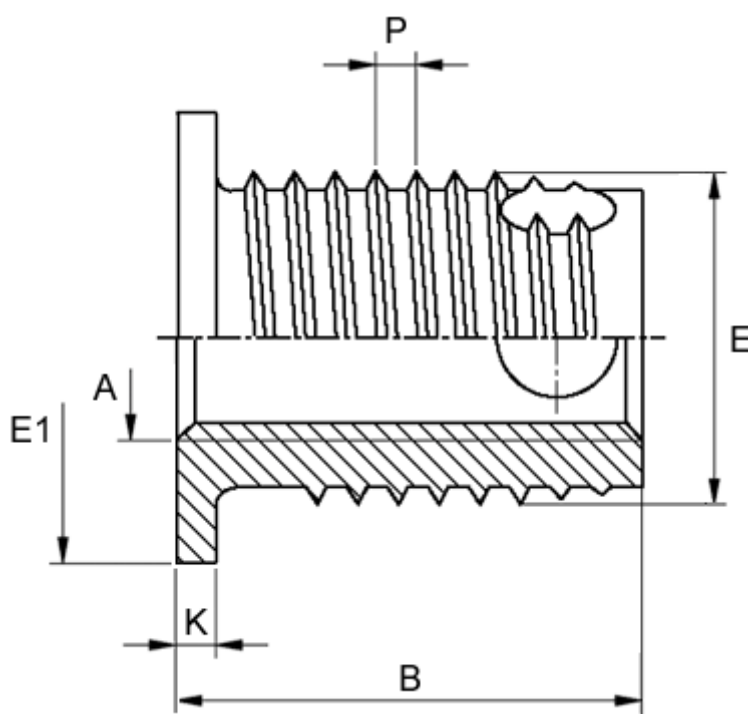

Female thread A	= M10
Flange diameter E1	= 17
Flange height	= 1.5
Length B	= 19.5
Male thread E	= 14
Min hole depth blind hole	= 22
Thread pitch P	= 1.50
Type	= 308 100 100 ...